

HORIBA

SEC-R100 Series:

Industrial Mass
Flow Controller



**Robust
Reliable
Repeatable
Reproducible**

SEC-R100 Series

Industrial Mass Flow Controller

Industrial Mass Flow Controllers are used in a variety of process applications where high levels of product performance, quality and integrity are demanded. HORIBA's SEC-R100 Series provides high accuracy and performance together with gas and flow range user configurability for critical process gas control applications.



Overview

HORIBA has built an enviable reputation in high technology semiconductor markets throughout the world by consistently delivering products with superior performance characteristics, high quality, and excellent reliability.

HORIBA's Digital Mass Flow Controller SEC-R100 is designed for high technology applications, where products need to be robust, providing high accuracy and repeatability, day after day and year after year. Typical applications are in; Vacuum Coating, Bioreactor, Food & Beverage, Pharmaceutical and Analytical.

The SEC-R100 has a multi gas/multi range function allowing users to change the gas type and full scale range for the nine most popular gases.

Communications are available in digital (PROFIBUS) and analog with 24 VDC power supply.

All HORIBA products are comprehensively supported locally by our global support network.

Applications

The SEC-R100 Series is suitable for applications that need a mass flow controller for the nine most popular gases;

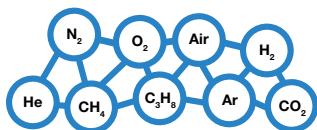

and where high accuracy mass flow control of critical process gases is required. The SEC-R100 enables users to change the gas type in situ whilst maintaining system integrity.

Industries:

- Bioreactor / Pharmaceutical: process control of reactor gases for fermentation, bioreactor gas management.
- Food & Beverage: blending, process control in bottling, drying, mixing, cooling, protective gases for packaging.
- Furnaces: flame / burner control, gas mixing and blending.
- Vacuum coating: process gases for thin film deposition processes.
- Analytical / Gas Analyzers: analytical sampling, gas sample preparation and measurement, verifying flow and pressure for multiple gases flowing to and from gas chromatographs.
- Automotive: emissions testing, emissions monitoring, measuring compressed air.
- Heat treatment: burner control, welding.

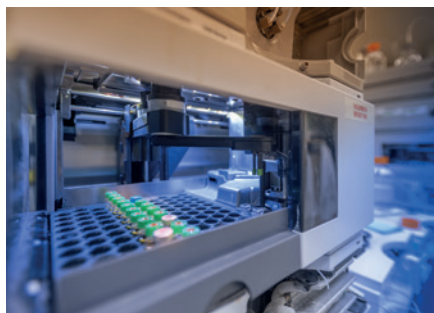
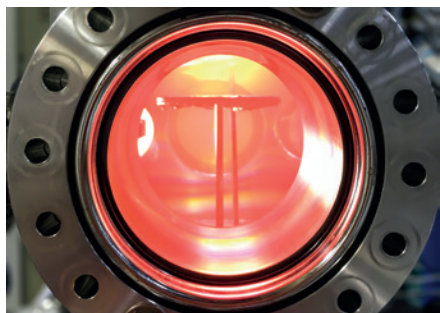

Product features

Robust:

- The SEC-R100 is robust and will give many years of service in various applications from clean laboratories to potentially contaminated industrial manufacturing environments.

Reliable:

- Users will benefit from HORIBA's experience in the semiconductor market which demands a high level of control with accuracy resulting in superior quality and reliability.
- When support is required, the HORIBA global support network will be on hand to work with you to resolve the issue.
- High Accuracy: +/- 1.0% S.P. (Flow rate >30% F.S.)

Repeatable:

- Within +/- 0.5% of F.S.
- Day after day and year after year, the SEC-R100 can maintain the same level of accuracy every time within +/- 0.5% of F.S.
- HORIBA's products are designed to operate with a high duty cycle; 24 hours a day, seven days a week.
- Built to satisfy the demands of high value manufacturing processes.

Reproducible:

- HORIBA's stringent quality control standards ensure each product matches the same performance as the next. Each and every time you will benefit from the same out-of-the-box functionality, accuracy and performance.

The SEC-R100 uses the latest "Variable PID System", which enables < 1 second response to all set-points. This system changes the PID continuously for optimum response to flow setting changes, ensuring fast response even when the full scale range or specified gas is changed.

- Digital/Analog communication: PROFIBUS® DP-V0, Analog 0-5, 0-10 VDC, 4-20 mA
- 24 VDC power supply

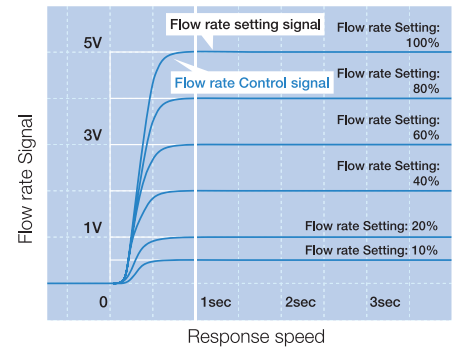

Users can change gas types and the full scale with a simple PC connection, even insitu. This function is suitable for users who use mass flow controllers with a variety of gases, who need to change the gas type frequently, and who need to change the flow range. The benefits of the multi gas/multi range function are:

- Manufacturing: easy change of process gas reduces down-time and improves productivity.
- R&D and laboratories: users can change their test conditions without switching MFCs.
- Supply chain: users can reduce inventory costs by stocking a single part number where previously multiple parts were required to cover a number of gases and flow rates.

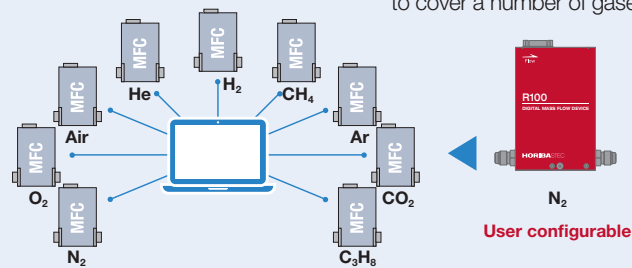

Specifications

Model Name	SEC-R116	SEC-R126
Full-scale flow rate (N2 conversion flow rate)	< 10LM	< 50LM
Compatible gas	N ₂ , O ₂ , Air, H ₂ , He, CH ₄ , C ₃ H ₈ , Ar, CO ₂	
Flow rate control range	2-100%F.S.	
Accuracy	±1.0%S.P. (Flow rate >30%F.S.)± 0.3%F.S. (Flow rate ≤ 30%F.S.)	
Operation temperature	5 to 50°C (recommended temperature range: 15 to 45°C)	
Response	≤ 1second over full flow rate range	
Valve type	Normally Closed	
Linearity	within +/- 0.5% of F.S.	
Repeatability	within +/- 0.2% of F.S.	
Power	24 VDC (13 to 32 VDC) 7.5 VA	
Digital	Profibus DP-V0	
Analog	0-5 (10) VDC, 4-20 mA	
Standard fitting	1/4" Swagelok equivalent	
Leak integrity	≤1×10 ⁻¹⁰ Pa • m ³ /s	
MAX. Operating pressure	450 kPa (G)	
Operating differential pressure	Up to 3SLM = N ₂ 50 ~ 300 kPa (D) >3SLM ~ 10SLM = 100 ~ 300 kPa (D) >10SLM 200~300 kPa (D)	
Wetted materials	SUS316L, PTFE, Elastomer, Magnetic Stainless steel and Fluoro Rubber	

External dimensions

HORIBA

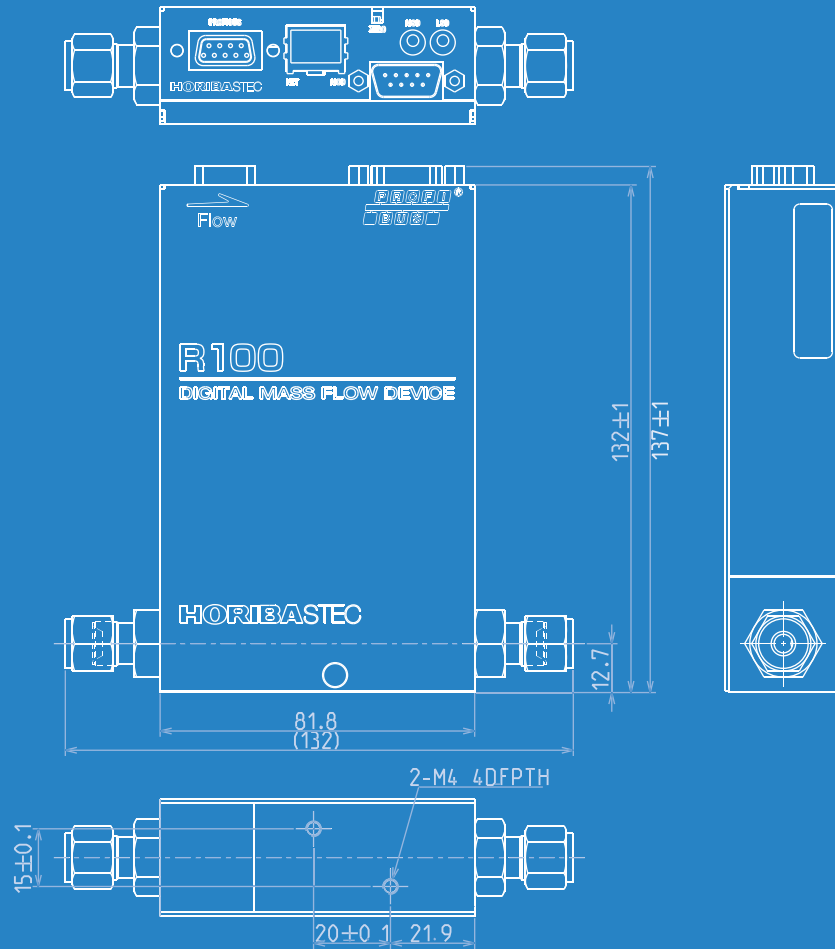

Structure and operating principles of digital mass flow controller

The general structure of the SEC-R100 Series of mass flow controller is shown in the diagram to the right. These mass flow controllers have a flow rate measurement section that includes a thermal sensor and matched bypass. The flow control is managed by a high performance solenoid flow rate control valve. The two sections are married by the electronics that utilises a superfast CPU and electronics to manage the PID and communications.

The gas is input at the inlet and is divided so that it flows over both the flow rate sensor

and bypass. The sensor measures the mass flow rate of the gas and the flow control valve regulates the flow rate so that the difference between the measured flow rate and the flow rate received from the external flow rate setting signal is 0 (zero).

The units feature a special loop circuit. Even if there is a secondary pressure change or ambient temperature change, that could affect the supply pressure of the introduced gas, the flow rate is instantaneously corrected; which ensures stable flow rate control every time.

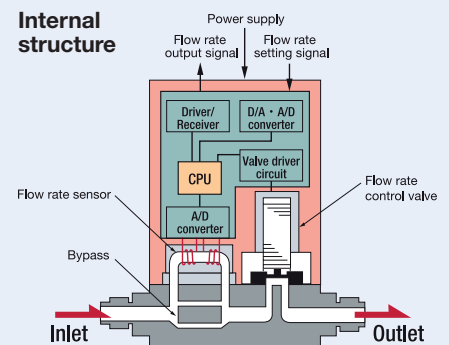

For further information about HORIBA contact:

HORIBA UK Limited

Kyoto Close, Summerhouse Road,
Moulton Park
Northampton NN3 6FL
UK

+44 1604 542 500
+44 1604 542 699
enquiries.uk@horiba.com

HORIBA Instruments Incorporated

Sunnyvale Office
430 Indio Way,
Sunnyvale California 94085
USA

+1 408 730 4772
+1 408 730 8975